



Real Bronze

Solid Cast Bronze has been used for centuries in the production of fine quality door and window fittings. For over 75 years, Frank Allart have been manufacturing real bronze furniture using skills and craftsmanship passed down through generations.

Offered in two forms, highly polished or antiqued, the real beauty of bronze furniture is how the surface finish matures. Unlike brass, real bronze is not protected with a lacquer coating. In the highly polished form the finish will either maintain its brilliance through handling, or age gracefully as the bronze oxidises.

This oxidized form is offered as an original finish and has always been a popular choice with discerning specifiers. Traditionally known as real bronze metal antiqued (RBMA), this unique iridescent patina is produced using a special process to rapidly oxidize the surface after highly polishing. The appeal of this finish is that, with constant handling, the oxide film will slowly wear down to reveal the beauty of the polished bronze beneath. Surfaces that are not handled, or are only handled occasionally, will retain their patina.

Both finishes will benefit from the occasional application of a good wax polish to maintain their sheen.



**1024 BALL KNOB
ON PLATE**
knob size : 48 dia

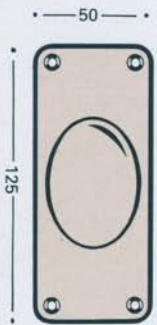

**1032 OVAL KNOB
ON PLATE**
knob size : 59 x 40

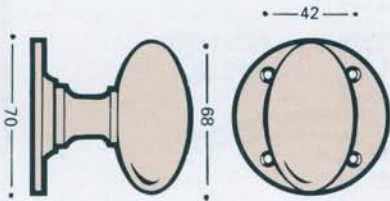

1016 OVAL KNOB

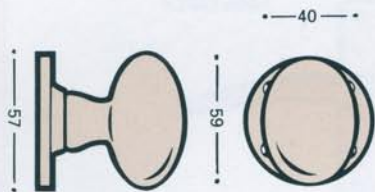

**1021 OVAL KNOB
2999 C/W MICROTITE
SPINDLE**



1023 BALL KNOB
• plain design

3000 C/W MICROTITE
SPINDLE

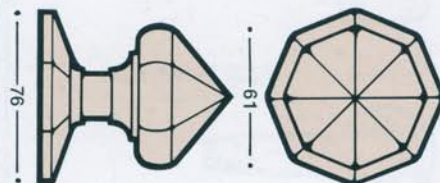

1068 OCTAGONAL KNOB

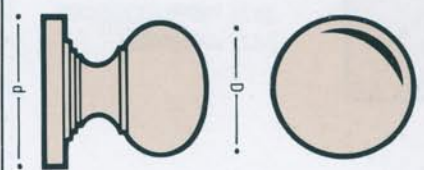

3034 BUN KNOB



| size | knob D | rose d |
|------|-----------|-----------|
| A | 51 | 57 |
| B | 57 | 64 |
| C | 64 | 70 |

LEVER FURNITURE

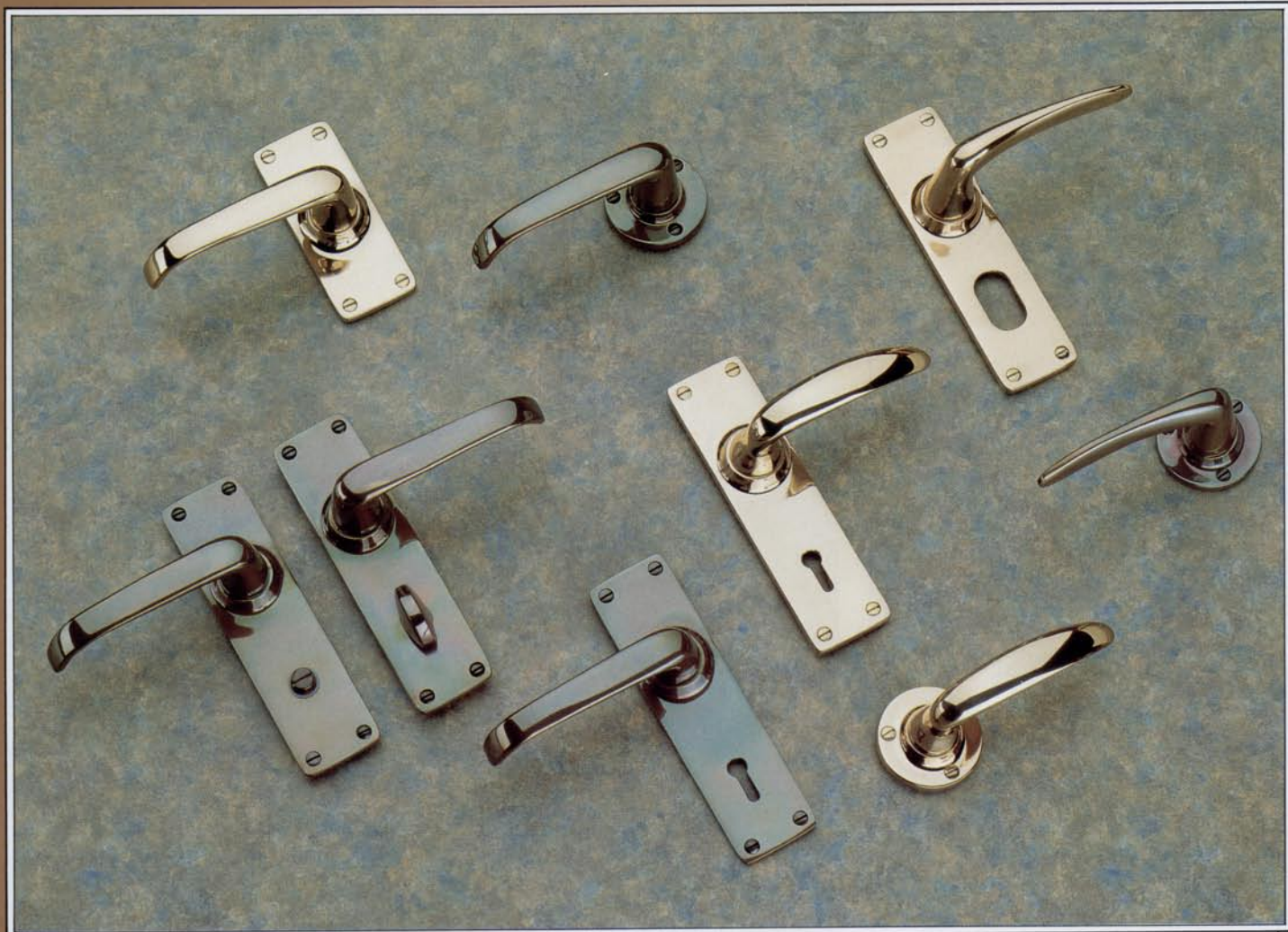

5421 LATCH
5422 LOCK

5424 OVAL CYLINDER
5425 PROFILE CYLINDER
5427 BATHROOM



5416 LATCH

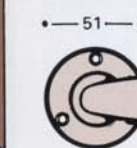

5410 ROUND ROSE



5251 LATCH
5252 LOCK

5254 OVAL CYLINDER
5255 PROFILE CYLINDER
5257 BATHROOM



5246 LATCH

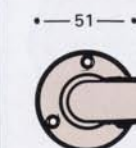

5220 ROUND ROSE



5471 LATCH
5472 LOCK

5474 OVAL CYLINDER
5475 PROFILE CYLINDER
5477 BATHROOM



5466 LATCH

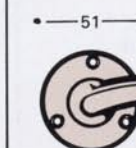

5460 ROUND ROSE

LOCK ACCESSORIES

• - 38 - •

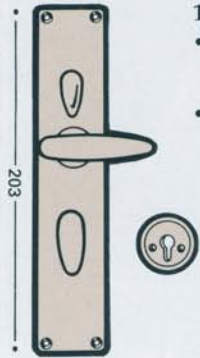

- 1218 LOCK SET**
- designed to suit Chubb 3R35 locking latch
 - reversible lever

• - 50 - •

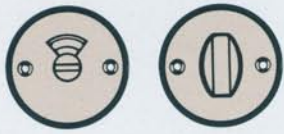

- 0144 TURN & RELEASE**
- red/green indication
 - coin operated release
 - 5mm spindle

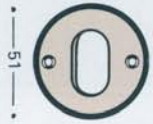

- 3007U OVAL/UNION
3007E EURO PROFILE**



- 1893U OVAL/UNION
1893E EURO PROFILE**
- screw-on cover to conceal fixings



- 1892 ESCUTCHEON**
- sunk design



- 0173 ESCUTCHEON**
- swing cover



- 0155 ESCUTCHEON**
- pear drop design
 - swing cover

• - 19 - •



- 2667 OVAL KNOB TURN**
- to suit mortice deadbolt
 - 5mm spindle



FLUSH FITTINGS

• - W - •

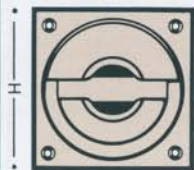

- 1086 FLUSH RING HANDLE**
- supplied with 8mm spindle to operate mortice latch
- sizes : 65 x 65
(W x H) 75 x 75
90 x 90

• - 41 - •



- 1157 FLUSH PULL**

• - 64 - •



- 1159 FLUSH PULL**

CUPBOARD KNOBS

• - S - •



- 0681 CUPBOARD KNOB**
- oval design
 - face fixed with woodscrews
- sizes S : 32, 38

• - S - •



- 0682 CUPBOARD KNOB**
- oval design
 - concealed rear bolt fixed
- sizes S : 32, 38

PULL HANDLES & FINGER PLATES

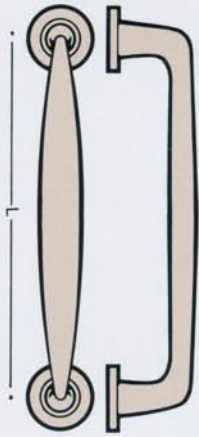

4340 PULL HANDLE
 • concealed face fixing
 sizes L : 175, 228, 310, 380

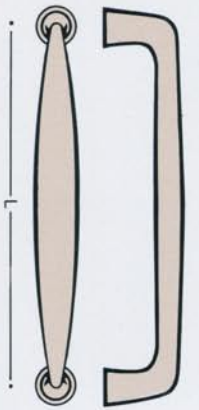

4336 PULL HANDLE
 • rear bolt fixing
 sizes L : 175, 228, 310, 380

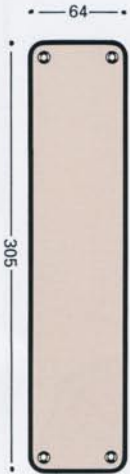

1440 FINGER PLATE
 • solid cast
 • designed to match
 1440 pull handle

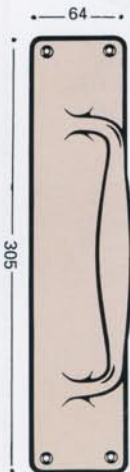

1440 PULL HANDLE
 • face fixed
 • rear bolt fixing
 available upon
 request



4305 PULL HANDLE
 • face fixed
 sizes L : 229, 305



1435 PULL HANDLE
 • face fixed
 • rear bolt fixing
 available upon
 request
 sizes L : 203, 254, 305



1442 PULL HANDLE
 • face fixed
 sizes L : 152, 184



ENTRANCE DOOR & CLOAKROOM FITTINGS

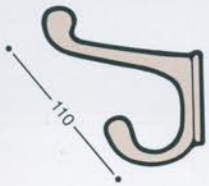

1319 HAT & COAT HOOK

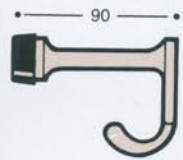

6293 BUFFERED HAT & COAT HOOK

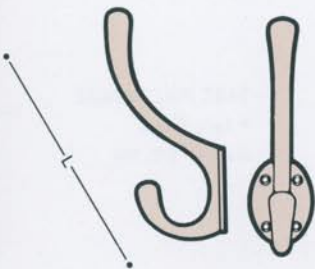

1279 HAT & COAT HOOK
lengths L : 120,150

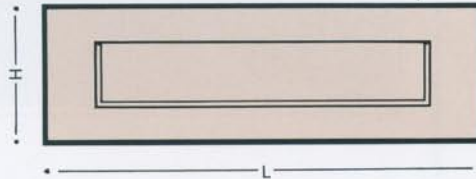

1101 LETTER PLATE

- sprung flap
- sizes : 254 x 89
- (L x H) 305 x 96
- 356 x 127
- 406 x 127



1997U OVAL/UNION
1997E EURO PROFILE
• face fixed



1996 CYLINDER PULL

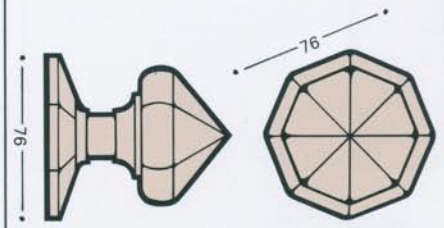

1068CDK CENTRE DOOR KNOB
• octagonal design



0093 NUMERAL
• concealed pin fixing

WINDOW FITTINGS & BOLTS

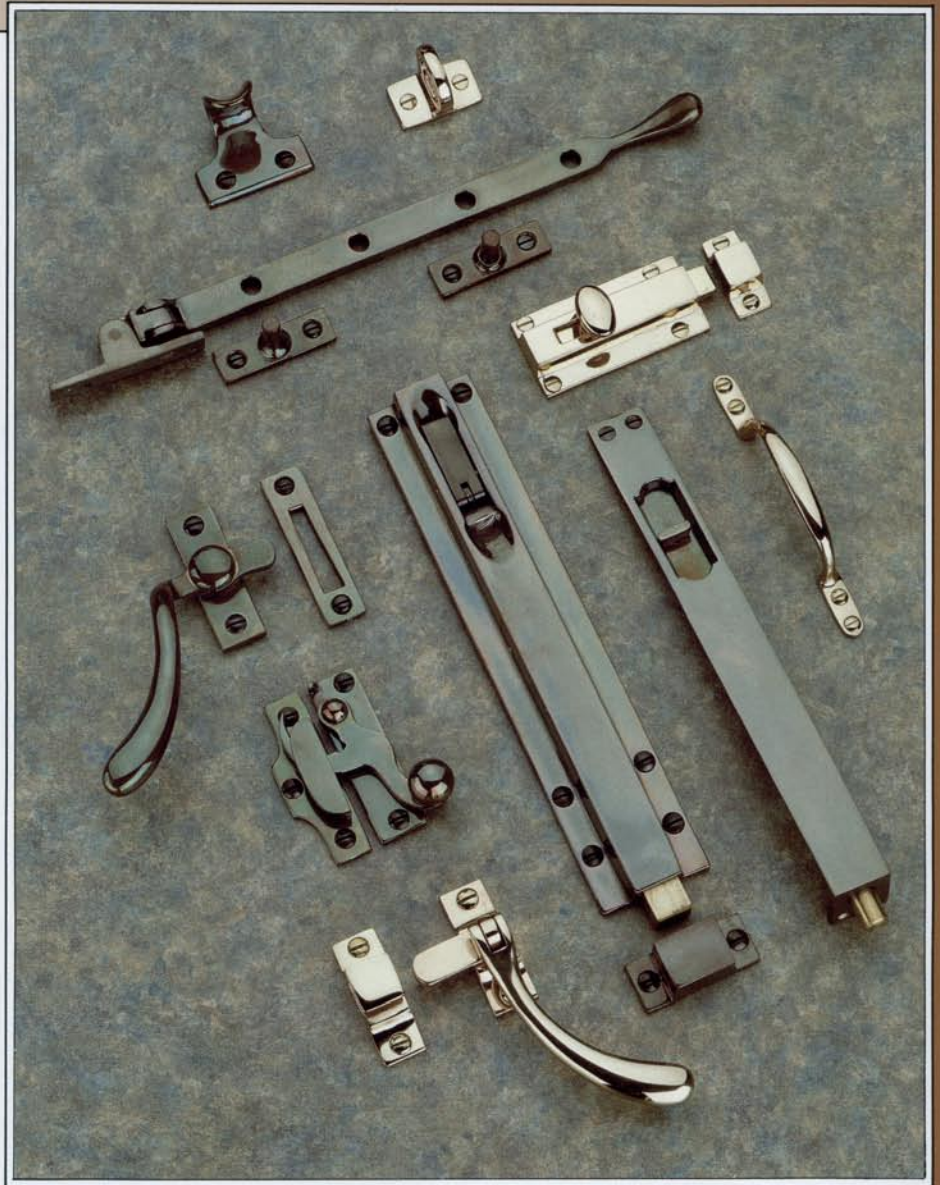

0222M CASEMENT FASTENER C/W MORTICE PLATE

- please specify LH or RH when ordering

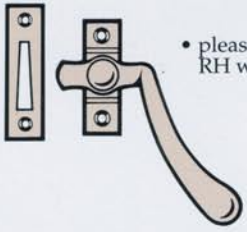

0222H CASEMENT FASTENER C/W HOOK PLATE

- please specify LH or RH when ordering

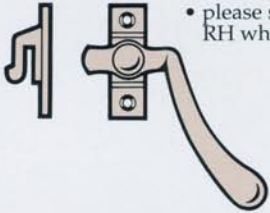

0340M CASEMENT FASTENER C/W MORTICE PLATE

- reversible handle

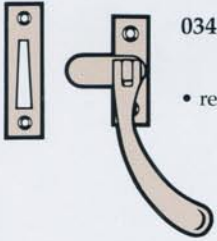

0340H CASEMENT FASTENER C/W HOOK PLATE

- reversible handle

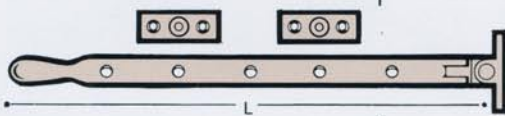
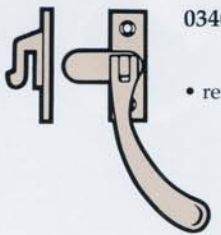

0372 CASEMENT STAY

- lengths L : 203
254
305

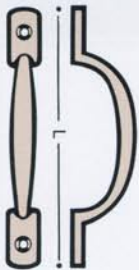

1436 SASH HANDLE
lengths L : 102, 127, 152



1009 SASH EYE

• 21 •

0992C SASH LIFT

• 50 •



• 50 •

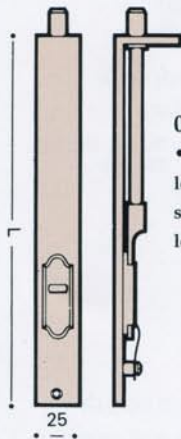

0443 BOLT

- sunk slide action
- lengths L : 152, 229, 305
shoot diameter : 11
length of throw : 16

• 25 •

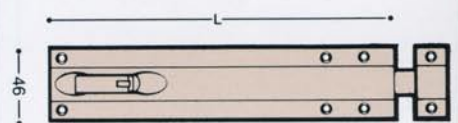

0454 BOLT

- lever action
- lengths L : 229, 305
shoot size : 16 x 13
length of throw : 16

• 76 •

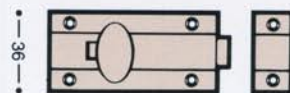

0448 DOOR BOLT

- knob slide action



0181 SASH FASTENER

• 75 •

BRACKETS, HOOKS, DOOR STOPS & HOLDERS



3189 HANDRAIL BRACKET
lengths L : 65, 75

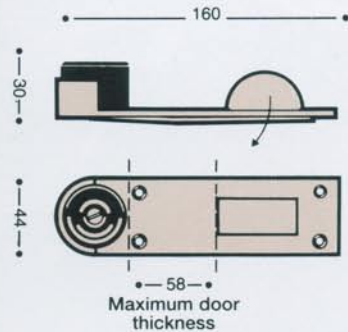

2117 DOOR STOP/HOLDER

- floor mounted
- bottom of door rides over spring loaded plunger automatically holding door open
- simply pull door to release



2118 DOOR STOP

- skirting board mounted

 lengths L : 51, 63, 76

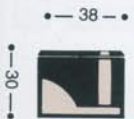

2089 DOOR STOP

- floor mounted



2112 DOOR STOP

- floor mounted



2112T DOOR STOP

- floor mounted
- particularly suitable for use with deep pile carpets or stepped thresholds

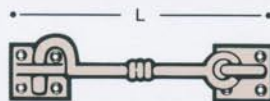

0476 CABIN HOOK

- heavy duty

 lengths L : 76, 102, 152, 203, 254, 305

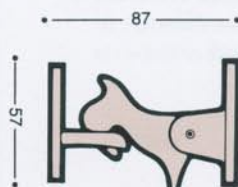

2108 DOOR HOLDER

- door to wall mounted
- automatic latching
- manual release



Our Special Product Service offers adaptations to standard products, special surface finishes, and the manufacture of bespoke designs.

Our Design Department, utilizing sophisticated Computer Aided Design equipment, has the capabilities, knowledge and experience to undertake all aspects of product design and development.

Please contact our Sales Department who will be pleased to provide a quotation against your requirements, with drawings and prototypes available upon request.



F R A N K A L L A R T

Frank Allart & Company Ltd

15/35 Great Tindal Street, Ladywood, Birmingham, B16 8DR, UK.

Tel: 0121- 410 6000 Fax: 0121- 410 6066

International · Tel: +44 (0)121- 410 6000 Fax: +44 (0)121- 410 6066

e-mail: sales@allart.co.uk Web Site: www.allart.co.uk

